

Article number: 01010151
 Description: Retaining ring A 5 DIN 471
 Stainless 411
 Note: Fitted with ZGA pilers

Measures

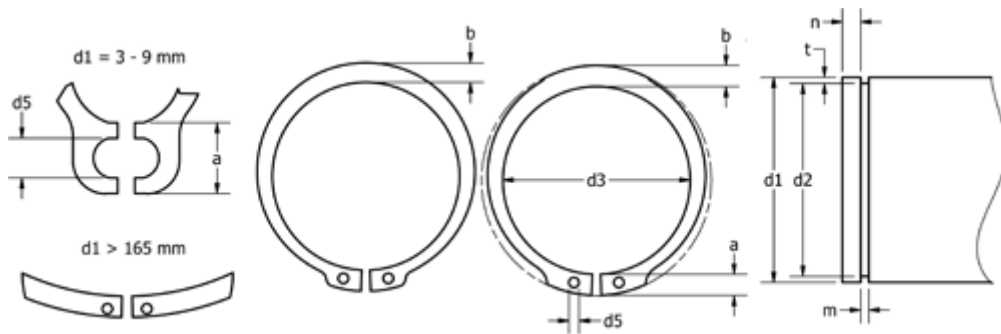

a max	= 2.5	FN kN	= 0.2	s	= 0.60
AN mm ²	= 1.5	FRg kN	= 0.80	t	= 0.10
b	= 1.1	FR kN	= 1.00	tol	= -0.04
d1	= 5	g	= 0.5	tol	= -0.05
d2	= 4.8	K kN-mm	= 7.38	tol	= +0,04-0,15
d3	= 4.7	m min	= 0.70	Tong	= ZGA-0
d5 min	= 1.0	n abl x 1000	= 154.0	Weight kg/1000	= 0.066
Description	= A5	Nominal drive	= 0.3		